

Standard Klein-Aggregate

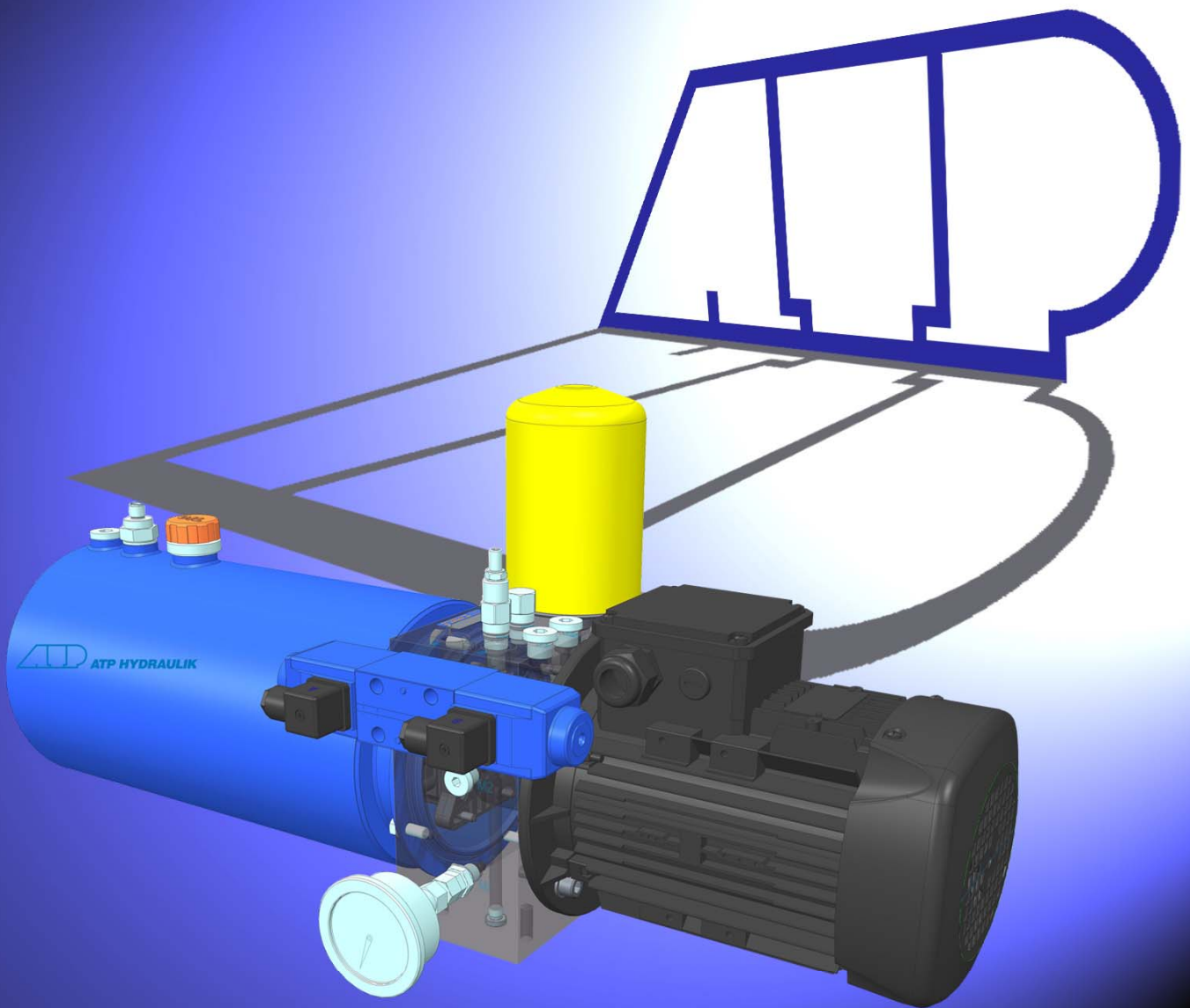

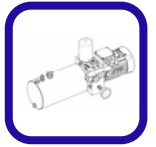

Inhaltsverzeichnis

Komponentenüberblick.....	2
Typenschlüssel.....	3
Typ.....	3
Fördermenge/Motorleistung.....	3
Behälter.....	3
Druckbegrenzung V1.....	3
Rückschlagventil Option Kühler V2.....	4
Rückschlagventil Pumpe V4.....	4
Manometer.....	4
Niveau-/Temperaturschalter.....	4
Heizung.....	4
Ventile auf Sektion NG6.....	4
Schema zu Bestellbeispiel.....	5
Sandwich-Ventile zu Sektion NG06.....	6
1 Druckbegrenzungventile.....	6
2 Druckregelventile.....	6
3 Lasthalteventile.....	7
4 Rückschlagventile.....	7
5 Strom- und Drosselrückschlagventil.....	8
Schieber-Ventile zu Sektion NG06.....	9
4/3-Wege-Ventil.....	9
4/2-Wege-Ventil.....	9
4/2-Wege-Ventil.....	9
4/3-Wege-Ventil proportional.....	9
Blind-/Umlenplatte.....	10

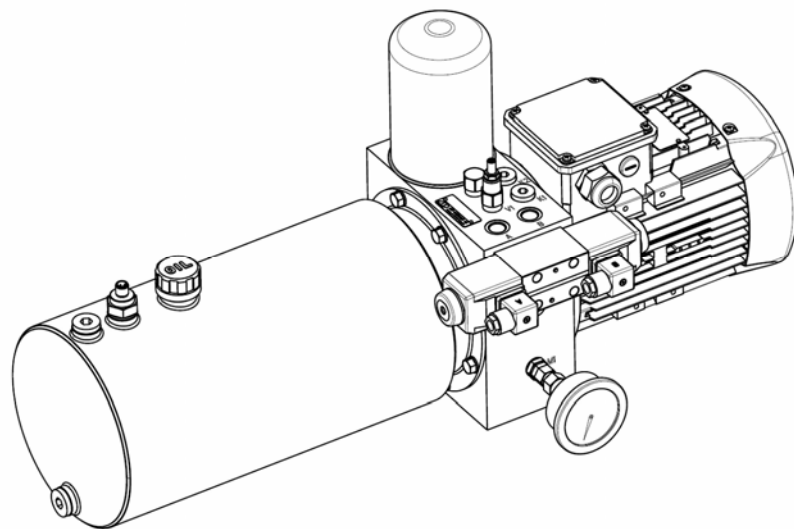

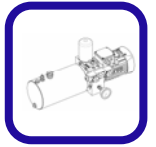

Komponentenüberblick

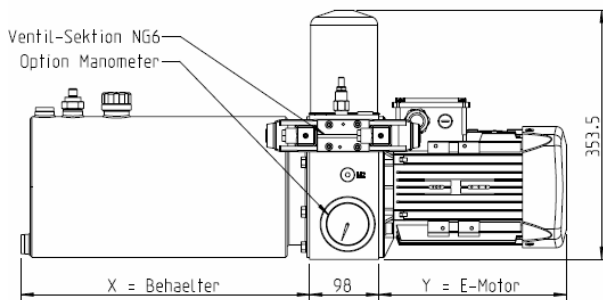
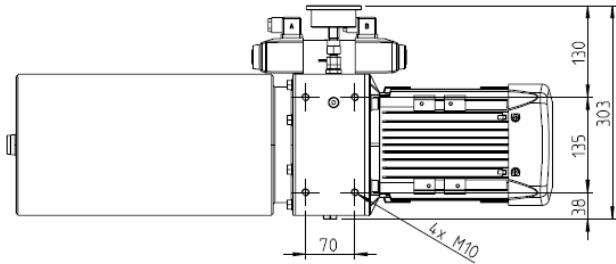

	Leistung	Länge Y
A	0.55 kW	250 mm
B	0.75 kW	250 mm
C	1.10 kW	275 mm
D	1.50 kW	300 mm
E	2.20 kW	338 mm
F	3.00 kW	387 mm

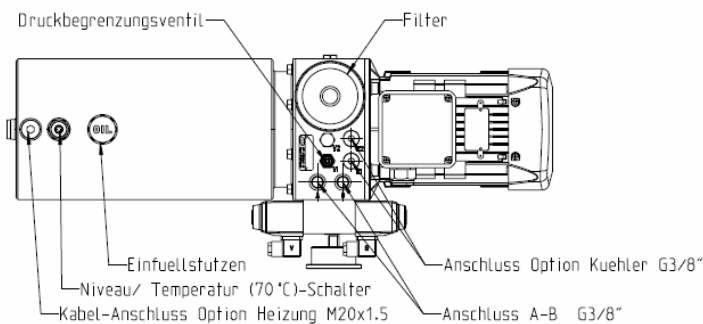

	Behältervolumen	Länge X
S10	10 L	410 mm
S18	18 L	700 mm

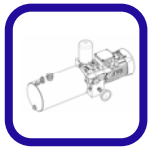

Typenschlüssel

Grösse und Leistung										/	Basisfunktionen							/	Ventilsektion NG6														
1	2	3	-	4	5	6	7	8	9	10	/	11	12	13	14	15	16	/	17
M	P	U	-								/							/															

Bestellbeispiel:

M P U - 0 3 D 1 S 1 0 / D K P M C H / G 5 B 1 C B

1 2 3 **Typ**

MPU = Mini Power Unit

Fördermenge/Motorleistung

E-Motor 4-polig (50Hz, ca.1440 U/min)

4 5	Fördermenge	Druck	Leistung	6 7
01=	1.4 l/min	110 bar	0.55 kW	= A1
		190 bar	0.75 kW	= B1
		300 bar (S)	1.10 kW	= C1
02=	2.8 l/min	55 bar	0.55 kW	= A1
		95 bar	0.75 kW	= B1
		165 bar	1.10 kW	= C1
		245 bar	1.50 kW	= D1
03=	4.2 l/min	300 bar (S)	2.20 kW	= E1
		40 bar	0.55 kW	= A1
		60 bar	0.75 kW	= B1
		110 bar	1.10 kW	= C1
04=	5.6 l/min	160 bar	1.50 kW	= D1
		245 bar	2.20 kW	= E1
		25 bar	0.55 kW	= A1
		45 bar	0.75 kW	= B1
05=	7.0 l/min	75 bar	1.10 kW	= C1
		115 bar	1.50 kW	= D1
		185 bar	2.20 kW	= E1
		15 bar	0.55 kW	= A1
		35 bar	0.75 kW	= B1
06=	8.4 l/min	60 bar	1.10 kW	= C1
		85 bar	1.50 kW	= D1
		140 bar	2.20 kW	= E1
		10 bar	0.55 kW	= A1
		30 bar	0.75 kW	= B1

E-Motor 2-polig (50Hz, ca.2880 U/min)

4 5	Fördermenge	Druck	Leistung	6 7
02=	2.8 l/min	45 bar	0.75 kW	= B2
		115 bar	1.10 kW	= C2
		200 bar	1.50 kW	= D2
		300 bar (S)	2.20 kW	= E2
04=	5.6 l/min	20 bar	0.75 kW	= B2
		55 bar	1.10 kW	= C2
		95 bar	1.50 kW	= D2
		165 bar	2.20 kW	= E2
06=	8.4 l/min	245 bar	3.00 kW	= F2
		30 bar	1.10 kW	= C2
		60 bar	1.50 kW	= D2
		110 bar	2.20 kW	= E2
07=	11.2 l/min	160 bar	3.00 kW	= F2
		20 bar	1.10 kW	= C2
		40 bar	1.50 kW	= D2
		80 bar	2.20 kW	= E2
08=	14.0 l/min	115 bar	3.00 kW	= F2
		30 bar	1.50 kW	= D2
		55 bar	2.20 kW	= E2
09=	16.8 l/min	85 bar	3.00 kW	= F2
		25 bar	1.50 kW	= D2
		50 bar	2.20 kW	= E2
		75 bar	3.00 kW	= F2

8 9 10 **Behälter**

S10 = Stahl 10 Liter

S18 = Stahl 18 Liter

11 **Druckbegrenzung V1**

0 = ohne Druckbegrenzungsventil

D = mit Druckbegrenzungsventil

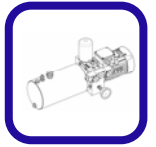
**12 *Rückschlagventil Option Kühler V2***

0 = ohne Rückschlagventil
K = mit Rückschlagventil 2bar

13 *Rückschlagventil Pumpe V4*

0 = ohne Rückschlagventil
P = mit Rückschlagventil

14 *Manometer*

0 = ohne Manometer
M = mit Manometer
N = mit Messanschluss

15 *Niveau-/Temperaturschalter*

0 = ohne Niveau-/Temperaturschalter
A = Niveau-Schalter
B = Niveau-Schalter + Temperaturschaltpunkt 50°C
C = Niveau-Schalter + Temperaturschaltpunkt 60°C
D = Niveau-Schalter + Temperaturschaltpunkt 70°C
E = Niveau-Schalter + Temperaturschaltpunkt 80°C
F = Niveau-Schalter mit 2 programmierbaren Temperaturschaltpunkte und Anzeige

16 *Heizung*

0 = ohne Heizung
H = mit Heizung 230V / 250W

17ff *Ventile auf Sektion NG6*

Die Sandwich-Ventile und Schieberventile sind in derselben Reihenfolge zu definieren, wie die Ventilgehäuse durchflossen werden. Siehe dazu das Bestellbeispiel mit dem dazu passenden Schema.

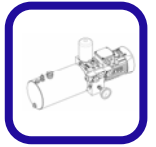

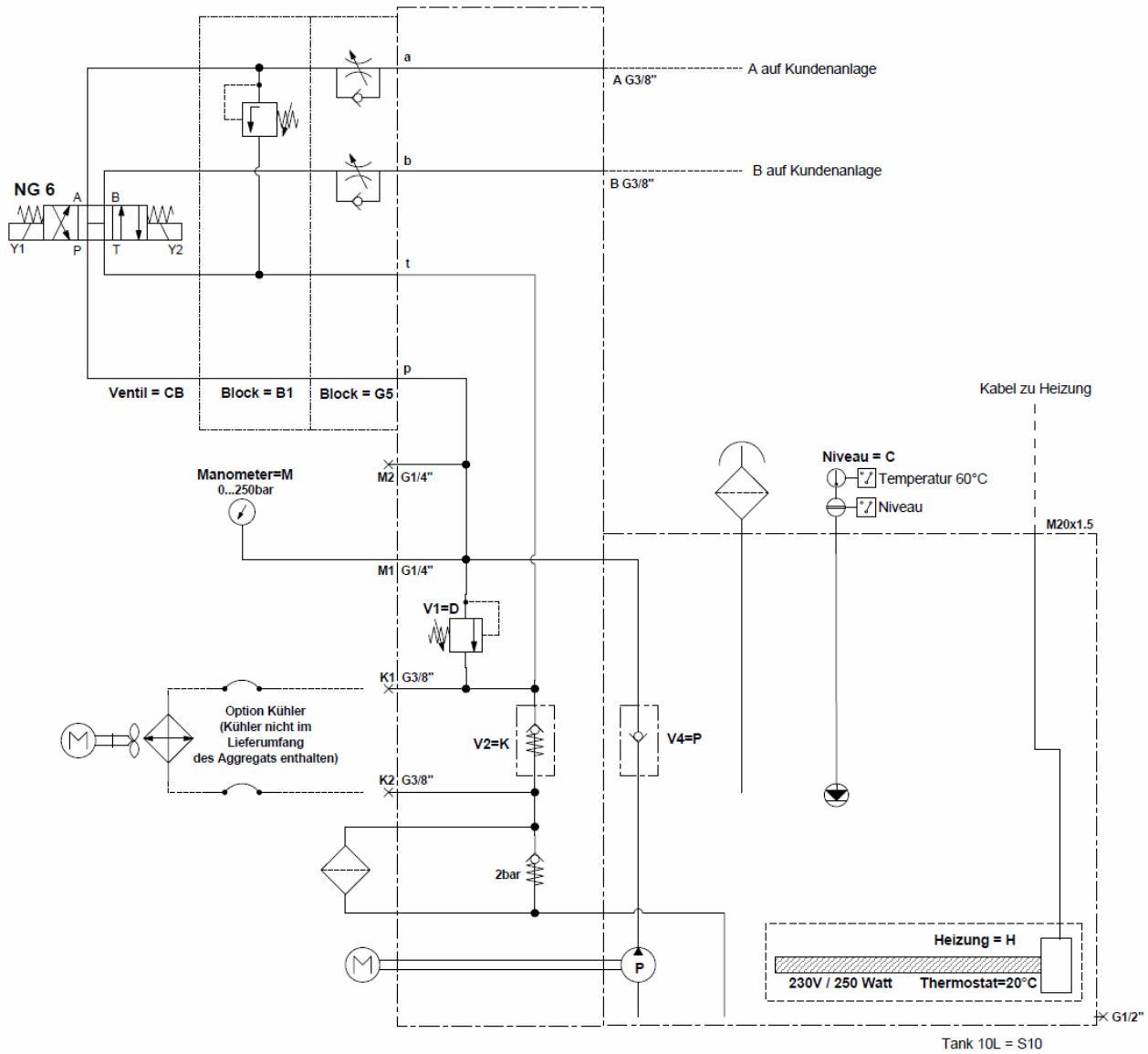

Schema zu Bestellbeispiel

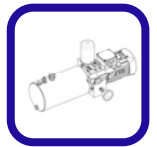





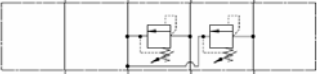

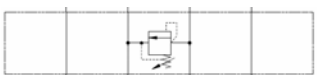

Sandwich-Ventile zu Sektion NG06

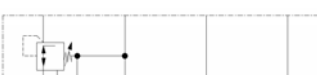
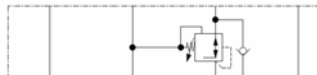
1 Druckbegrenzungsventile

A1 =		P nach T		D1 =		A nach T B nach T
B1 =		A nach T		E1 =		A nach B B nach A
C1 =		B nach T				

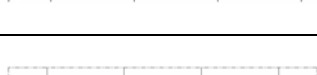
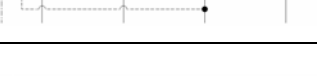



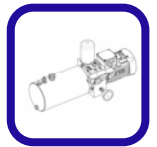

2 Druckregelventile

A2 =		Druckminderventil in P		E2 =		Druckminderventil in B (mit RSV)
B2 =		Druckminderventil in P (geregelt mit A)		F2 =		Druckminderventil in A+B (mit RSV)
C2 =		Druckminderventil in P (geregelt mit B)		N2 =		2-Wege- Druckwaage
D2 =		Druckminderventil in A (mit RSV)		O2 =		3-Wege- Druckwaage



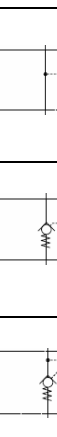

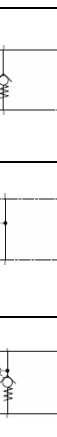

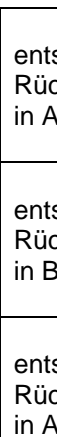
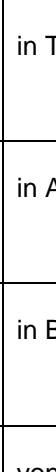
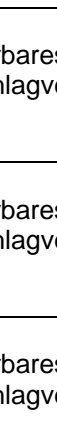



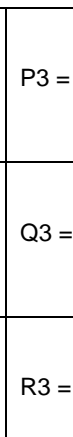
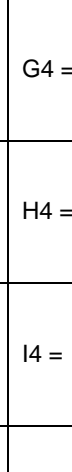

3 Lasthalteventile

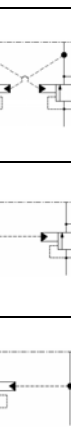
A3 =		entsperrbares Rückschlagventil in A	P3 =		Senkbremsventil in A+B
B3 =		entsperrbares Rückschlagventil in B	Q3 =		Senkbremsventil in A atmosphärisch entlastet
C3 =		entsperrbares Rückschlagventil in A+B	R3 =		Senkbremsventil in B atmosphärisch entlastet
N3 =		Senkbremsventil in A	S3 =		Senkbremsventil in A+B atmosphärisch entlastet
O3 =		Senkbremsventil in B			

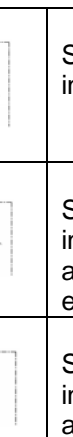



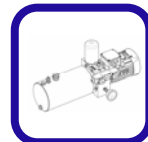

4 Rückschlagventile

A4 =		in P	F4 =		von T nach A
B4 =		in T	G4 =		von T nach B
C4 =		in A	H4 =		von T nach A+B
D4 =		in B	I4 =		von A nach B
E4 =		von T nach P	J4 =		von B nach A

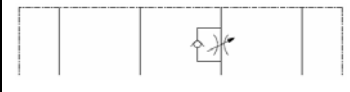



5 Strom- und Drosselrückschlagventil

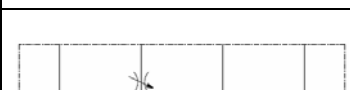

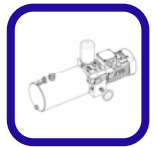

A5 =		Drossel in P	E5 =		DRV in B Ablauf ge- drosselt
B5=		DRV in A Zulauf ge- drosselt	F5 =		DRV in A+B Zulauf ge- drosselt
C5 =		DRV in A Ablauf ge- drosselt	G5 =		DRV in A+B Ablauf ge- drosselt
D5 =		DRV in B Zulauf ge- drosselt	H5 =		Drossel in T





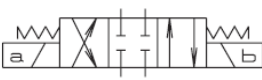



Schieber-Ventile zu Sektion NG06



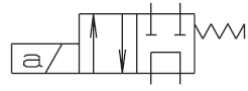

4/3-Wege-Ventil

CA =				CC =			
CB =				CD =			

4/2-Wege-Ventil

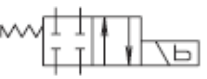
AA =				AD =			
AB =				AE =			
AC =							

4/2-Wege-Ventil

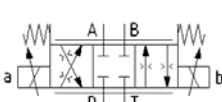
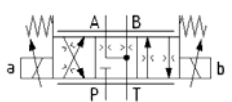

BA =				BD =			
BB =				BE =			
BC =							

4/3-Wege-Ventil proportional

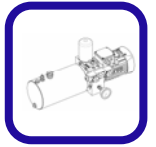
PA =				PC =			
------	---	--	--	------	--	--	--

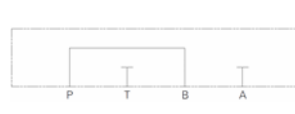
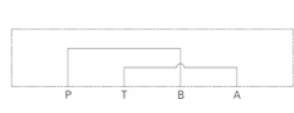
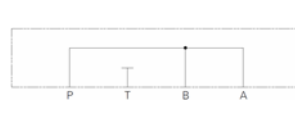

Blind-/Umlenkplatte

EA =				EE =			
EB =				EF =			
EC =				EG =			
ED =	